



深圳市希恩凯电子有限公司

SHENZHEN CNK ELECTRONIC CO.,LTD.

Product Specification For LCD Module

Model NO.: CNKT0240-17001B1

CUSTOMER ITEM NO.

REVISION : A

APPROVAL FOR SPECIFICATIONS ONLY

APPROVAL FOR SPECIFICATIONS AND SAMPLE

CUSTOMER :

APPROVED BY :

CNK LCM R&D CENTER

APPROVED BY

CHECKED BY

PREPARED BY



DIRECTOR

MANAGER

Engineer

深圳市希恩凯电子有限公司

SHEN ZHEN CNK ELECTRONICS CO., LTD

地址 1: 深圳市宝安区沙井南环路鸿桥工业园 2 期 b 栋 4 楼

地址 2: 惠州市惠阳区西湖村铭仕工业园 2 栋 1-2 楼

电话: 0752-3556001

传真: 0752-3556004

<http://www.szcnk.com>



 深圳市希恩凯电子有限公司 SHENZHEN CNK ELECTRONIC CO.,LTD.	MODEL NO.		PAGE
	CNKT0240-17001B1	SPEC SAMPLE	2

TABLE OF CONTENTS

NO	CONTENTS	PAGE
1	Record OF Revision	3
2	General Description	4
3	Mechanical Specification	4
5	Lcd Electro-Optical Characteristics	5
6	Lcd Optical Characteristics	5
7	Optical Characteristics Definition	6
8	Interface pin assignment	7
9	Backligram	8
10	Block Diagram	9
11	AC Characteristics	10
12	Reliability	11
13	Inspection Criteria	12-13
14	Precaution For Use OF Lcd Module	14-15
15	Lcm Drawing	16

 深圳市希恩凯电子有限公司 SHENZHEN CNK ELECTRONIC CO.,LTD.	MODEL NO.		PAGE
	CNKT0240-17001B1	SPEC SAMPLE	4

2. General Description

CNKT0240-15001B1-LCM is a 240*320 dots matrix TFT LCD module. It has a TFT panel composed of 240 sources and 320 gates. The LCM can be easily accessed by micro-controller.

3. MECHANICAL SPECIFICATION

ITEM	CONTENTS
Display Mode	TFT Graphic 240RGB*320Dot-matrix
Input Data	16 bits parallel interface by 8080 MPU
Viewing Direction	12 o'clock
Drive	ILI9341V
Dimensional outline	42.72(H) x 60.26(V) x (3.40T)
Resolution	240RGB*320
LCD Active area	36.72(H) x 48.96(V)
Pixel size	0.153(H) x 0.153(V)
Weight	TBD

5. LCD ELECTRO-OPTICAL CHARACTERISTICS (Ta=25°C)

Item	Symbol	Condition	Min.	Typ.	Max.	Unit
LCD Module Driving Voltage	VDD	Ta=25°C	2.8	3.0	3.3	Volt
Operating Temperature	Top	--	-20°C	-	+70°C	°C
Storage Temperature	Tst	--	-30°C	-	+80°C	°C
Humidity	%	--	--	-	90%	

Note: See section 12 for backlight uniformity measurement

6. LCD OPTICAL CHARACTERISTICS

Item	Symbol	Temp(°C)	Rating			Unit	Reference	
			Min	Typ	Max			
Recommended Driving Voltage	Vop	50				V		
		25	8.8	9.0	9.2			
		0						
Response Time	Rise Time	Tr	25	180	230	ms	Note4	
	Fall Time	Tf	25	180	230			
Frame Frequency	FR	25	70	75	80	Hz		
Viewing angle Cr ≥ 2	∅=0°	θ ₁	25	25		Deg	Note1 Note2	
	∅=180°	θ ₂		25				
	∅=90°	θ ₃		15				
	∅=270°	θ ₄		45				
Viewing Direction		12 O'clock						
Contrast Ratio	Cr	25	6	8			Note3	

7. OPTICAL CHARACTERISTICS DEFINITION

Note 1. Definition of angle θ_1 & θ_2

Note 2. Definition of angle θ_3 & θ_4

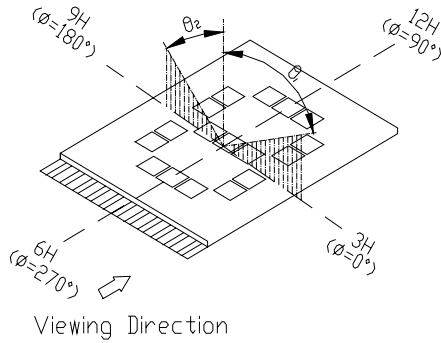
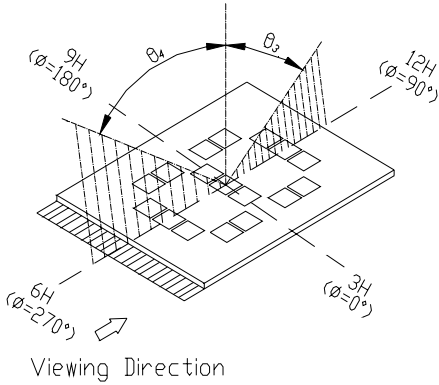

LCD Panel

Note 3. Definition of contrast ratio (Cr2)

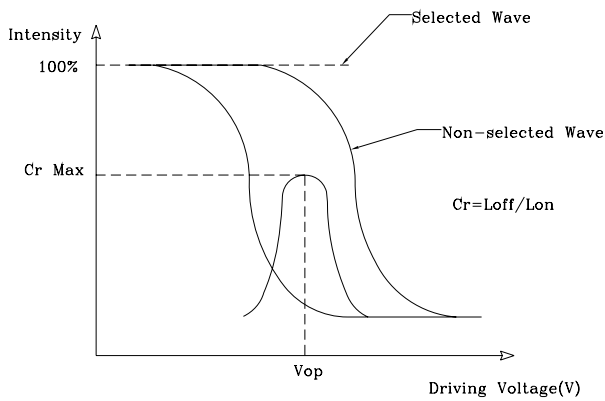

[Positive type]

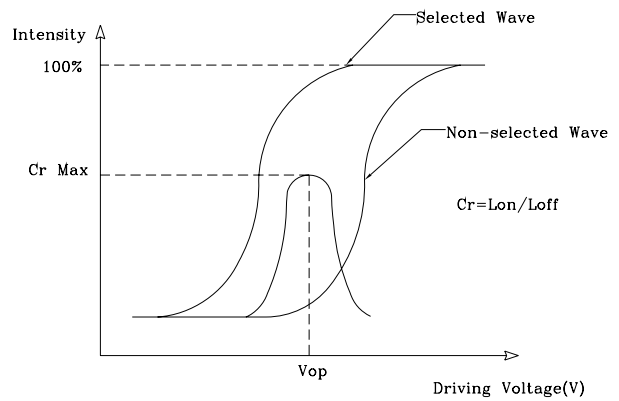

[Negative type]

Note 4. Definition of response time

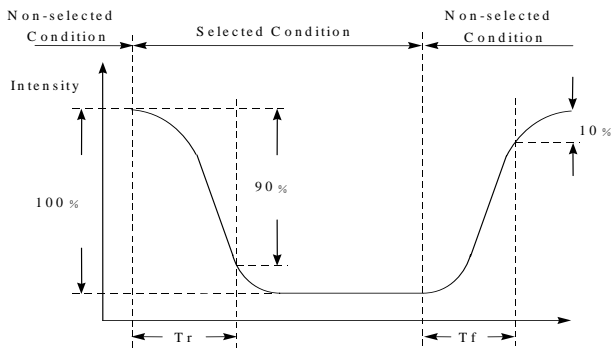

[positive type]

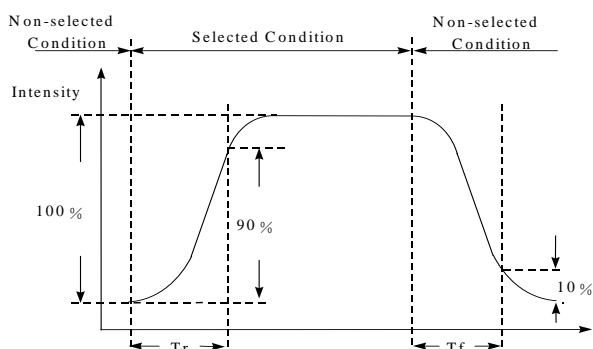

[Negative type]

8. INTERFACE PIN ASSIGNMENT

9. BACKLIGHT

BACKLIGHT ELECTRICAL-OPTICAL CHARACTERISTICS (Unless specified, Ambient temperature Ta=25°C)

PARAMETER	Sym.	Min.	Typ.	Max.	Unit	Test Condition	Reference
Supply Current	I	--	60	80	mA	60mA	
LED	V	2.8	3.0	3.2	V	60mA	--
Backlight Luminous Intensity	Lv	--	--	--	Cd/m ²	60mA	Note1
Uniformity	--	70	--	--	%	60mA	Note1 Note2

NOTE:

1. Backlight luminance: The measurement instrument is BM-7 luminance colorimeter. The aperture of colorimeter is $\varnothing 5\text{mm}$ and the distance between lens and backlight is 50cm. 5 points will be measured and the luminance of backlight is the average value of 5 points.

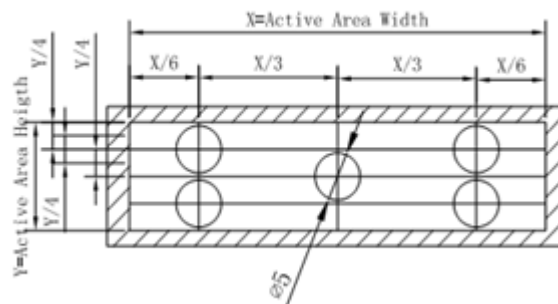

measure point on backlight

2. Backlight Uniformity = (The Luminance min / The Luminance max) x 100%

10.BLOCK DIAGRAM

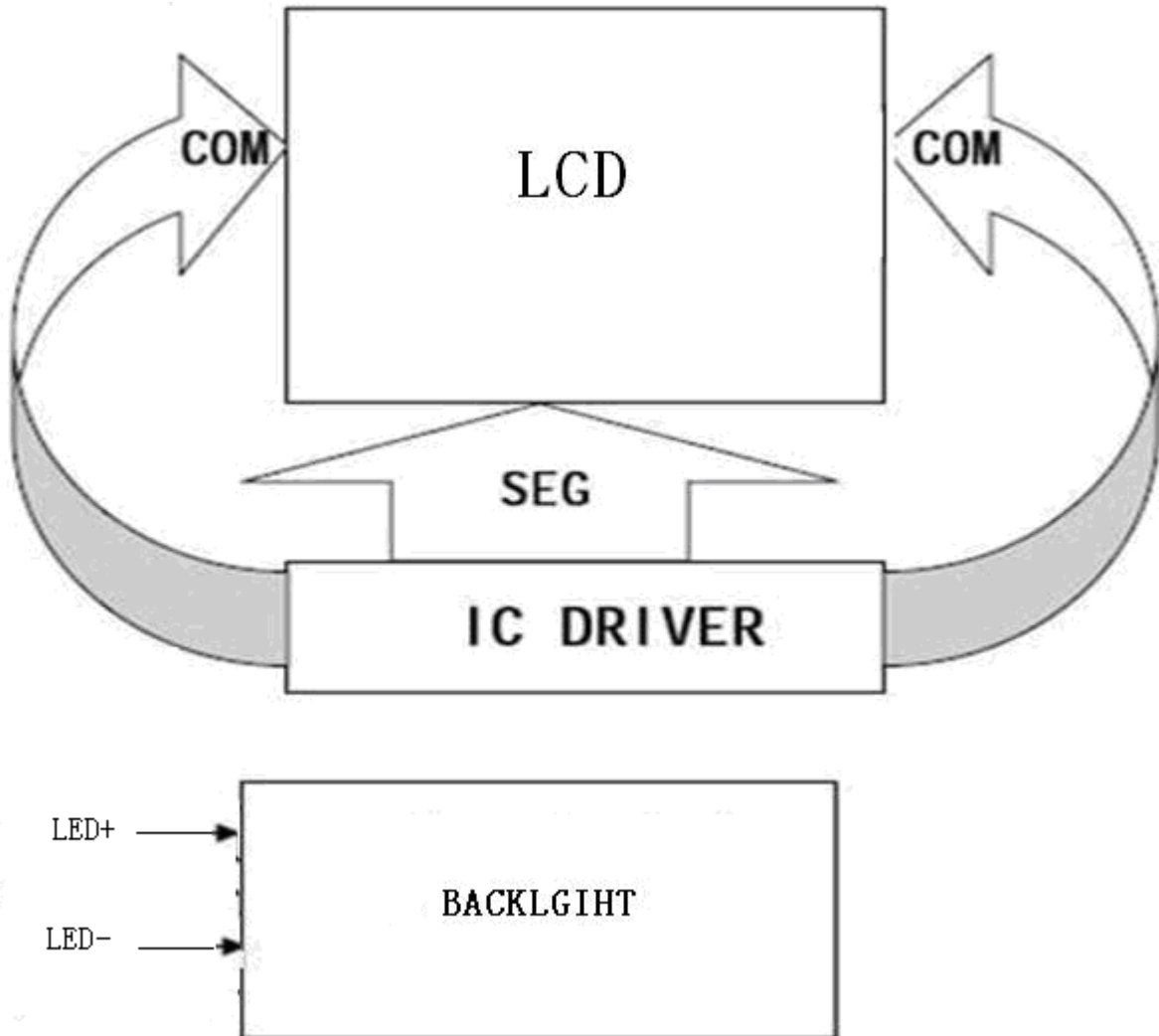

11.AC Characteristics

7.4 AC Characteristics

7.4.1 8080 Series MCU Parallel Interface Characteristics: 16/18/8-bit Bus

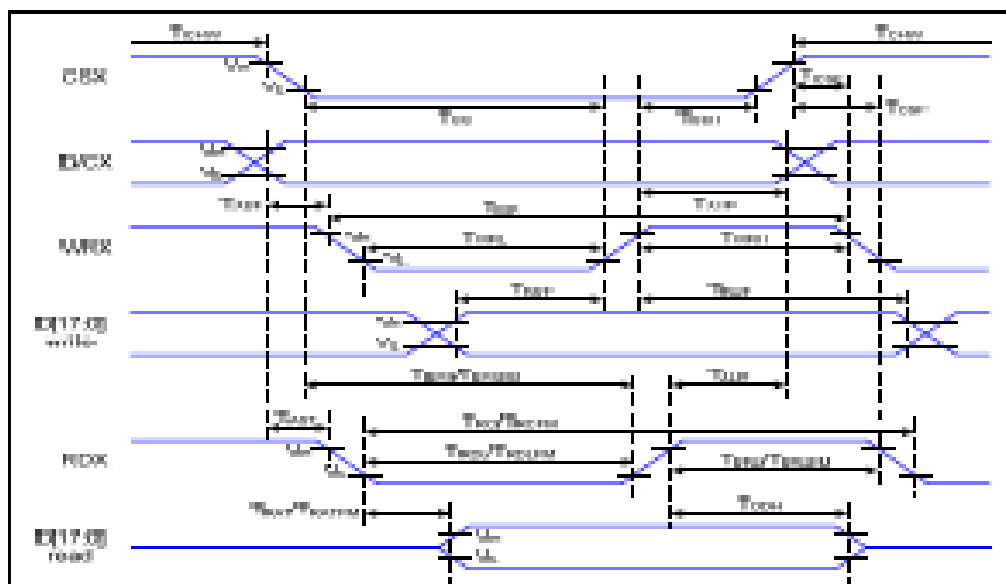

Figure 1 Parallel Interface Timing Characteristics (8080-Series MCU Interface)

$V_{DD}=1.65$ to $3.3V$, $V_{DD}=2.4$ to $3.3V$, $AGND=BGND=0V$, $T_{em} = -30$ to 70 °C

Signal	Symbol	Parameter	Min	Max	Unit	Description
D/CX	T_{ASSET}	Address setup time	0		ns	-
	T_{AH}	Address hold time (Write/Read)	10		ns	
CSX	T_{CSH}	Chip select "H" pulse width	0		ns	-
	T_{CS}	Chip select setup time (Write)	15		ns	
	T_{CSA}	Chip select setup time (Read ID)	45		ns	
	T_{CSAFM}	Chip select setup time (Read FM)	355		ns	
	T_{CSW}	Chip select wait time (Write/Read)	10		ns	
	T_{CSH}	Chip select hold time	10		ns	
WRX	T_{WC}	Write cycle	66		ns	-
	T_{WRH}	Control pulse "H" duration	15		ns	
	T_{WEL}	Control pulse "L" duration	15		ns	
RD[17:0] (ID)	T_{RC}	Read cycle (ID)	160		ns	When read ID data
	T_{RDH}	Control pulse "H" duration (ID)	90		ns	
	T_{REL}	Control pulse "L" duration (ID)	45		ns	
RD[17:0] (FM)	T_{RFM}	Read cycle (FM)	450		ns	When read from frame memory
	T_{RDHFM}	Control pulse "H" duration (FM)	90		ns	
	T_{RDLFM}	Control pulse "L" duration (FM)	355		ns	
D[17:0]	T_{DS}	Data setup time	10		ns	For $C_L=30pF$

12. RELIABILITY

	No	Test Item	Content of Test	Test Condition
Environment Test	1	High Temperature Storage	Endurance test of high temperature for a long time.	80℃ 96H
	2	Low Temperature Storage	Endurance test of low temperature for a long time.	-20±2℃ 96H
	3	High Temperature Operation	Endurance test of electrical stress (Voltage & Current) and the thermal stress to the element.	70℃ 96H
	4	High Temperature /Humidity Storage	Endurance Test of high temperature and high humidity for a long time.	45±2℃ 90±2%RH 96H
	5	Thermal shock	Endurance test of low and high temperature cycles.(air to air) $-20\pm 2^{\circ}\text{C} \longleftrightarrow 70\pm 2^{\circ}\text{C}$ $(60\text{min}) \longleftrightarrow (60\text{min})$ 1 cycle	-10±2℃/70±2℃ 10 cycle
	6	vibration	Maximum vibration is 2.45m/s ² (0.25 G) during operation and 11.75 m/s ² (1.2 G) during storage. Tested 10-100KHz XYZ directions 1 hour each.	Ambient temperature Ta=25℃
7	shock	Maximum shock is 29.4 m/s ² (3 G) during operation and 490.0 m/s ² (50 G) during storage. Tested 10 milliseconds in XYZ directions 1 time each.	Ambient temperature Ta=25℃	

Note:

- 1) Condensation is not allowed during low temperature testing.
- 2) Driving condition for operation test:

Power Supply Current for BackLight(I_{mA})=15mA

Failure Judgment Criterion

After the above mentioned test (For Environmental Test, after 2 hours in room temperature):

- 1) There should not be conspicuous failure of display quality and appearance.
- 2) Contrast ratio should be greater than or equal to 50% of the initial contrast ratio.
- 3) Abnormal function is a failure.

13. INSPECTION CRITERIA

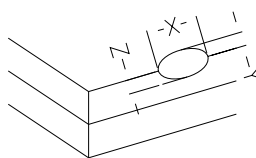
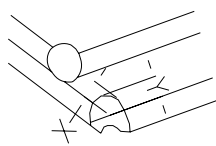
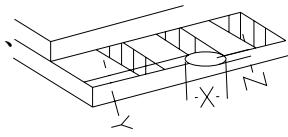
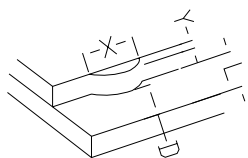
NO	Item	Criteria	AQL																		
1	Electrical Testing	(1) non-display (2) segment missing (3) segment short	0.65																		
2	Dimension state	Dimension out of the specification	1.00																		
3	Glass crack	<p>Substrate check symbol Definition: X: Length direction Y: Short side direction Z: Thickness direction T: Glass thickness K: LCD length L: Single connector width</p> <p>(1) General crack</p>  <table border="1" data-bbox="794 996 1324 1164"> <thead> <tr> <th>X</th> <th>Y</th> <th>Z</th> </tr> </thead> <tbody> <tr> <td>$1/8K \geq$</td> <td>Not over viewing area</td> <td>$T \geq$</td> </tr> </tbody> </table> <p>(2) Corner</p>  <table border="1" data-bbox="794 1209 1324 1377"> <thead> <tr> <th>X</th> <th>Y</th> <th>Z</th> </tr> </thead> <tbody> <tr> <td>$1/8K \geq$</td> <td>Not over viewing area</td> <td>No check</td> </tr> </tbody> </table> <p>(3) Contact pad crack</p>  <table border="1" data-bbox="877 1489 1332 1657"> <thead> <tr> <th>X</th> <th>Y</th> <th>Z</th> </tr> </thead> <tbody> <tr> <td>$1/8K \geq$</td> <td>$1/3L \geq$</td> <td>No check</td> </tr> </tbody> </table> <p>1. Cracks on the contact area cannot exceed 1/2 of the glass thickness. 2. Y not to exceed 1/3 seal width</p> <p>(4) Substrate protuberance and internal crack</p>  <p style="text-align: right;">$D < 2/3L$, Reject</p> <p>(5) No progressive glass cracks allowed</p>	X	Y	Z	$1/8K \geq$	Not over viewing area	$T \geq$	X	Y	Z	$1/8K \geq$	Not over viewing area	No check	X	Y	Z	$1/8K \geq$	$1/3L \geq$	No check	2.50
X	Y	Z																			
$1/8K \geq$	Not over viewing area	$T \geq$																			
X	Y	Z																			
$1/8K \geq$	Not over viewing area	No check																			
X	Y	Z																			
$1/8K \geq$	$1/3L \geq$	No check																			

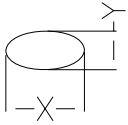
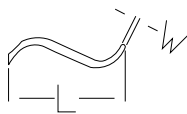
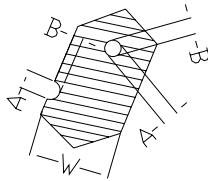
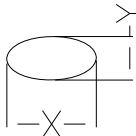
NO	Item	Criterion	AQL																								
4.	Black spot , white spot (including polarizer) $\varnothing = (X+Y) / 2$ unit:mm	<p>(1) Round type</p>  <table border="1" style="margin-left: 100px;"> <thead> <tr> <th>Size</th> <th>Acceptable QTY</th> </tr> </thead> <tbody> <tr> <td>$\varnothing \leq 0.10$</td> <td>Accept</td> </tr> <tr> <td>$0.10 < \varnothing \leq 0.20$</td> <td>2</td> </tr> <tr> <td>$0.20 < \varnothing \leq 0.25$</td> <td>1</td> </tr> <tr> <td>$0.25 < \varnothing$</td> <td>0</td> </tr> </tbody> </table> <p>(2) Line type</p>  <table border="1" style="margin-left: 100px;"> <thead> <tr> <th>Length L</th> <th>Width W</th> <th>Acceptable QTY</th> </tr> </thead> <tbody> <tr> <td>accept</td> <td>$0.015 \geq W$</td> <td>No check</td> </tr> <tr> <td>$3.0 \geq L$</td> <td>$0.050 \geq W$</td> <td rowspan="2">2</td> </tr> <tr> <td>$2.5 \geq L$</td> <td>$0.080 \geq W$</td> </tr> <tr> <td></td> <td>$0.100 < W$</td> <td>As round type</td> </tr> </tbody> </table> <p>(3) No more than 2 spots and lines within 3 mm. Maximum combined total of round and line defects is 4.</p> <p>(4) Scratches criterion is same as that of Round type.</p>	Size	Acceptable QTY	$\varnothing \leq 0.10$	Accept	$0.10 < \varnothing \leq 0.20$	2	$0.20 < \varnothing \leq 0.25$	1	$0.25 < \varnothing$	0	Length L	Width W	Acceptable QTY	accept	$0.015 \geq W$	No check	$3.0 \geq L$	$0.050 \geq W$	2	$2.5 \geq L$	$0.080 \geq W$		$0.100 < W$	As round type	1.50
Size	Acceptable QTY																										
$\varnothing \leq 0.10$	Accept																										
$0.10 < \varnothing \leq 0.20$	2																										
$0.20 < \varnothing \leq 0.25$	1																										
$0.25 < \varnothing$	0																										
Length L	Width W	Acceptable QTY																									
accept	$0.015 \geq W$	No check																									
$3.0 \geq L$	$0.050 \geq W$	2																									
$2.5 \geq L$	$0.080 \geq W$																										
	$0.100 < W$	As round type																									
5.	Pixel deformation	Symbols: W: segment width \varnothing : average of diameter $= (A+B) / 2$ (1) Pin hole and deformation  <table border="1" style="margin-left: 100px;"> <thead> <tr> <th>Width</th> <th>Acceptable Defect</th> </tr> </thead> <tbody> <tr> <td>$W < 0.4$</td> <td>$\varnothing \leq 0.20$ and $\varnothing \leq 1/2W$</td> </tr> <tr> <td>$W \geq 0.4$</td> <td>$\varnothing \leq 0.25$ and $\varnothing \leq 1/3W$</td> </tr> </tbody> </table> <p style="text-align: center;">\varnothing under 0.10mm ,acceptable</p> <p>(2) Pixel size should be in the range of 95% to 100% of the normal dimension and the gap between pixels should be less than 150% of normal dimension.</p>	Width	Acceptable Defect	$W < 0.4$	$\varnothing \leq 0.20$ and $\varnothing \leq 1/2W$	$W \geq 0.4$	$\varnothing \leq 0.25$ and $\varnothing \leq 1/3W$	2.5																		
Width	Acceptable Defect																										
$W < 0.4$	$\varnothing \leq 0.20$ and $\varnothing \leq 1/2W$																										
$W \geq 0.4$	$\varnothing \leq 0.25$ and $\varnothing \leq 1/3W$																										
6.	Polarizer bubble $\varnothing = (X+Y) / 2$	 <table border="1" style="margin-left: 100px;"> <thead> <tr> <th>size \varnothing</th> <th>Acceptable QTY</th> </tr> </thead> <tbody> <tr> <td>$\varnothing \leq 0.20$</td> <td>No check</td> </tr> <tr> <td>$0.20 < \varnothing \leq 0.50$</td> <td>3</td> </tr> <tr> <td>$0.50 < \varnothing \leq 1.00$</td> <td>2</td> </tr> <tr> <td>$1.00 < \varnothing$</td> <td>0</td> </tr> <tr> <td>Total QTY</td> <td>3</td> </tr> </tbody> </table>	size \varnothing	Acceptable QTY	$\varnothing \leq 0.20$	No check	$0.20 < \varnothing \leq 0.50$	3	$0.50 < \varnothing \leq 1.00$	2	$1.00 < \varnothing$	0	Total QTY	3	1.5												
size \varnothing	Acceptable QTY																										
$\varnothing \leq 0.20$	No check																										
$0.20 < \varnothing \leq 0.50$	3																										
$0.50 < \varnothing \leq 1.00$	2																										
$1.00 < \varnothing$	0																										
Total QTY	3																										
7.	Contrast	Under normal power supply, uneven contrast is unacceptable.	2.5																								
8.	Rainbow	Obvious uneven color in LCD viewing area is not allowed.	2.5																								

 深圳市希恩凯电子有限公司 SHENZHEN CNK ELECTRONIC CO.,LTD.	MODEL NO.		PAGE
	CNKT0240-17001B1	SPEC SAMPLE	1 4

14. PRECAUTION FOR USE OF LCD MODULE

1. Handling Precautions

- 1) The display panel is made of glass. Do not subject it to a mechanical shock by dropping it from a high place, etc.
- 2) If the display panel is damaged, the liquid crystal substance leaks out ,do not ingest. If the substance contacts skin or clothes, promptly wash off using soap and water.
- 3) Do not apply excessive force to the display surface or adjoining areas since this may affect the LCD color
- 4) The polarizer covering the display surface of the LCD module is soft and easily scratched. Handle this polarizer carefully.
- 5) If the display surface is contaminated, breathe on the surface and gently wipe it with a soft dry cloth. If still not completely clear, moisten cloth with one of the following solvents:
 - Isopropyl alcohol
 - Ethyl alcohol
 Solvents other than those mentioned above may damage the polarizer.
 Especially, do not use the following:
 - Water
 - Ketone
 - Aromatic solvents
- 6) Do not attempt to disassemble or process the LCD module.

2. Assembling Precautions

- 1) When mounting the LCD module make sure that it is free of twisting, warping, and distortion. Distortion has great influence upon display quality. Also, use an adequately stiff outer case.
- 2) Please handle the LCD module by its side.
- 3) NC terminal should be open. Do not connect anything.
- 4) If the logic circuit power is OFF, do not apply the input signals.
- 5) To prevent destruction of the elements by static electricity, be careful to maintain an optimum work environment.
 - Be sure to ground the body when handling the LCD module.
 - Tools required for assembly, such as soldering irons, must be properly grounded.
 - To reduce the amount of static electricity generated, do not conduct assembly and other work under dry conditions.
 - The LCD module is coated with a film to protect the display surface. Exercise care when peeling off this protective film since static electricity may be generated.
- 6) Be careful handling the glass panel because it has a very sharp edge.

3. Storage Precautions

 深圳市希恩凯电子有限公司 SHENZHEN CNK ELECTRONIC CO.,LTD.	MODEL NO.		PAGE
	CNKT0240-17001B1	SPEC SAMPLE	1 5

- 1) When storing the LCD module, avoid exposure to direct sunlight, to the light of fluorescent lamps, to high temperature or to high humidity. Whenever possible, LCD modules should be stored in the same packaging they were shipped in.
- 2) Exercise care to minimize corrosion of the electrodes. Corrosion of the electrodes is accelerated by water droplets or by current flow in a high-humidity environment.

4. Design Precautions

- 1) The absolute maximum ratings represent the rated value beyond which LCD module can not exceed. When the LCD modules are used in excess of this rated value, their operation characteristics may be adversely affected.
- 2) To prevent the occurrence of erroneous operation caused by noise, attention must be paid to satisfy V_{IL} , V_{IH} specification values including taking the precaution of using signal cables that are short.
- 3) The LCD exhibits temperature dependency characteristics. Since recognition of the display becomes difficult when the LCD is used outside its designated operating temperature range, be sure to use the LCD within this range. Also keep in mind that the LCD driving voltage levels necessary for clear displays will vary according to temperature.
- 4) We recommended that power supply lines (VDD) have over-current protection line. (Fuse etc. Recommend Value:0.5A)
- 5) Sufficiently reduce electrical noise from peripheral devices.
- 6) To cope with EMI, take measures basically on outputting side.
- 7) Assemble LCD module tightly with the application case or PCB.

5. Other considerations

- 1) Liquid crystal solidifies under low temperature (below the storage temperature range) leading to defective orientation or the generation of air bubbles (black or white). Air bubbles may also be generated if the LCD module is subjected to a strong shock at a low temperature.
- 2) If the LCD modules have been operating for a long time showing the same display patterns, the display patterns may remain on the screen as ghost images and a slight contrast irregularity may also appear. A normal operating status can be regained by suspending use for some time. It should be noted that this phenomenon does not adversely affect performance reliability.
- 3) To minimize the performance degradation of the LCD module's resulting from destruction caused by static electricity, etc., exercise care to avoid touching the LCD's electrical connections.
- 4) LCD voltage adjustment may be necessary to obtain the best contrast on each LCD.
- 5) Precaution for disposal of LCD module. When disposal of LCD module, ask specialization company of industrial waste which is permitted by the government. When burn up LCD module, obey the law of environmental hygienic.

Customer Approve By:

REV	DATE	DESCRIPTION	REVISER
01	2017-3-16	首次图纸	修改者

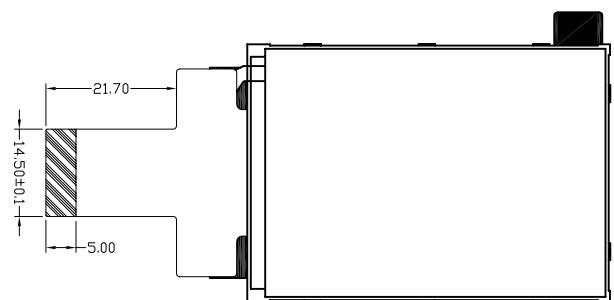
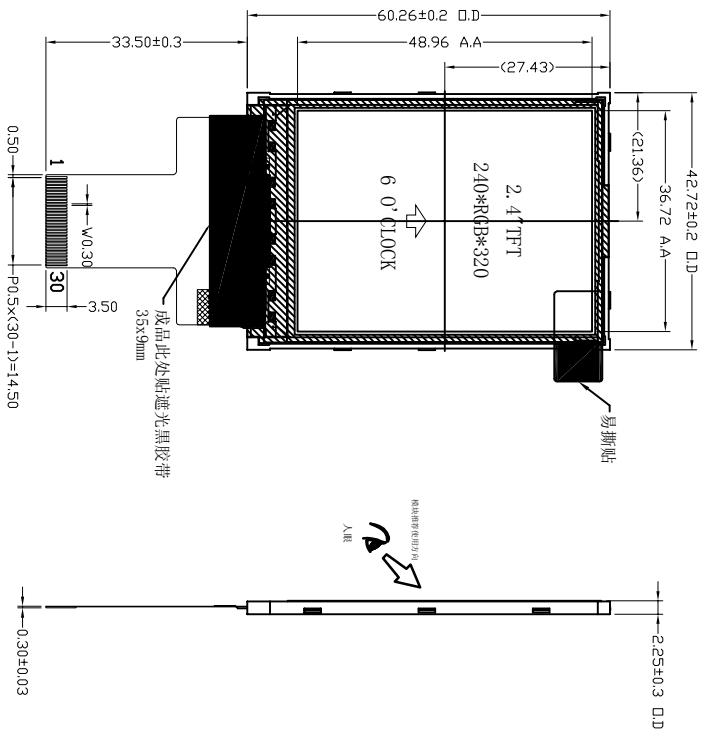

1	GND
2	DB0
3	DB1
4	DB2
5	DB3
6	DB4
7	DB5
8	DB6
9	DB7
10	DB8
11	DB9
12	DB10
13	DB11
14	DB12
15	DB13
16	DB14
17	DB15
18	CS
19	RS
20	WR
21	RD
22	RESET
23	VDD
24	VDD1
25	GND
26	LEDA
27	LEDK1
28	LEDK2
29	LEDK3
30	LEDK4

SPECIFICATION:

1. LCD Panel Size : 2.4 Inch(A.A Diagonal)
2. Resolution : 240*RGB(H)*320(V)
3. Display Mode : Normally White
4. Viewing Direction : 12:00(Gray inversion) 6:00(Human eye)
5. Operating/Storage temperature : -20°C~+70°C / -30°C~+80°C
6. Operating Voltage : VDD=2.4~3.3V VDD1=1.65~3.3V
7. LED Backlight : White, 4*20mA / 3.2V
8. Touch Panel : --
9. Control IC Interface : ILI9341V MCU 8/16bit
10. Dimensions with mark "O" are reference.
11. RoHS compliant. Unspecified tolerance ±0.2

注: 修改PIN数由33PIN改为30PIN

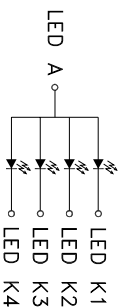

IM0=1
80-16bit parallel I/F
DB15-DB0

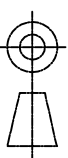

MODEL NO. CNK70240-17001B1

型号 批准

比例: 1:1 单位: mm

OUTLINE

CUSTOMER'S CODE
客户型号
CNK料号

EDITION
版本

02

CHECK
核对
设计

DRAW NO.
图号
1/1

DATE
日期
2017/04/06

A

1

2

3

由 Autodesk 教育版产品制作

6

7

8